

A Plane 1.88-Spanner for Points in Convex Position*

Mahdi Amani¹, Ahmad Biniiaz², Prosenjit Bose³,
Jean-Lou De Carufel⁴, Anil Maheshwari⁵, and Michiel Smid⁶

- 1 Dipartimento di Informatica, Università di Pisa, Pisa, Italy
m_amani@di.unipi.it
- 2 School of Computer Science, Carleton University, Ottawa, Canada
ahmad.biniiaz@gmail.com
- 3 School of Computer Science, Carleton University, Ottawa, Canada
jit@scs.carleton.ca
- 4 School of Electrical Engineering and Computer Science, University of Ottawa,
Ottawa, Canada
jdecaruf@uottawa.ca
- 5 School of Computer Science, Carleton University, Ottawa, Canada
anil@scs.carleton.ca
- 6 School of Computer Science, Carleton University, Ottawa, Canada
michiel@scs.carleton.ca

Abstract

Let S be a set of n points in the plane that is in convex position. For a real number $t > 1$, we say that a point p in S is t -good if for every point q of S , the shortest-path distance between p and q along the boundary of the convex hull of S is at most t times the Euclidean distance between p and q . We prove that any point that is part of (an approximation to) the diameter of S is 1.88-good. Using this, we show how to compute a plane 1.88-spanner of S in $O(n)$ time, assuming that the points of S are given in sorted order along their convex hull. Previously, the best known stretch factor for plane spanners was 1.998 (which, in fact, holds for any point set, i.e., even if it is not in convex position).

1998 ACM Subject Classification I.3.5 Computational Geometry and Object Modeling, G.2.2 Graph Theory, F.2.2 Nonnumerical Algorithms and Problems

Keywords and phrases points in convex position, plane spanner

Digital Object Identifier 10.4230/LIPIcs.SWAT.2016.25

1 Introduction

Let S be a set of n points in the plane. A *geometric graph* is a graph $G = (S, E)$ with vertex set S and edge set E consisting of line segments connecting pairs of vertices. The length (or weight) of any edge (p, q) in E is defined to be the Euclidean distance $|pq|$ between p and q . The length of any path in G is defined to be the sum of the lengths of the edges on this path. For any two vertices p and q of S , their shortest-path in G , denoted by $\delta_G^*(p, q)$, is a path in G between p and q that has the minimum length. We denote the length of $\delta_G^*(p, q)$ by $|\delta_G^*(p, q)|$. For a real number $t \geq 1$, the graph G is a t -spanner of S if for any two points p and q in S , $|\delta_G^*(p, q)| \leq t|pq|$. The smallest value of t for which G is a t -spanner is called

* Research supported by NSERC.



the *stretch factor* of G . A large number of algorithms have been proposed for constructing t -spanners for any given point set; see the book by Narasimhan and Smid [12].

In this paper, we consider *plane spanners*, i.e., spanners whose edges do not cross each other. Chew [4] was the first to prove that plane spanners exist; in fact, this was the first publication on geometric spanners. Chew proved that the L_1 -Delaunay triangulation of a finite point set has stretch factor at most $\sqrt{10} \approx 3.16$ (observe that lengths in this graph are measured in the Euclidean metric). In the journal version [5], Chew proves that the Delaunay triangulation based on a convex distance function defined by an equilateral triangle is a 2-spanner.

Dobkin *et al.* [7] proved that the L_2 -Delaunay triangulation is a t -spanner for $t = \pi(1 + \sqrt{5})/2 \approx 5.08$. Keil and Gutwin [10] improved the upper bound on the stretch factor to $t = \frac{2\pi}{3\cos(\pi/6)} \approx 2.42$. This was subsequently improved by Cui *et al.* [6] to $t = 2.33$ for the case when the point set is in convex position. Currently, the best result is due to Xia [13], who proved that t is less than 1.998.

Thus, the current best upper bound on the stretch factor of plane spanners is 1.998. Regarding lower bounds, by considering the four vertices of a square, it is obvious that a plane t -spanner with $t < \sqrt{2}$ does not exist. Mulzer [11] has shown that every plane spanning graph of the vertices of a regular 21-gon has stretch factor at least 1.41611. Recently, Dumitrescu and Ghosh [8] improved the lower bound to 1.4308 for the vertices of a regular 23-gon.

1.1 Our Results

In this paper, we consider plane spanners for point sets that are in convex position. Currently, it is known that the stretch factor of any such spanner is less than 1.998. Moreover, the best lower bound is 1.4308. We improve the upper bound to 1.88. Our approach is as follows.

Let S be a finite and non-empty set of points in the plane and assume that S is in convex position. We denote the boundary of the convex hull of S by $CH(S)$. For any two points p and q in S , let $\delta_{CH(S)}^{cw}(p, q)$ and $\delta_{CH(S)}^{ccw}(p, q)$ denote the clockwise and counter-clockwise paths from p to q along $CH(S)$, respectively, and let $\delta_{CH(S)}^*(p, q)$ be the shorter one. Let $t \geq 1$ be a real number, and let p and q be two points of S . We say that p is t -good for q in S if $|\delta_{CH(S)}^*(p, q)| \leq t|pq|$. Observe that if p is t -good for q , then q is t -good for p . We say that the point $p \in S$ is t -good for S if p is t -good for all points of S . Define

$$t^* = \inf\{t : \text{each finite and non-empty set of points in the plane} \\ \text{that is in convex position has at least one } t\text{-good point}\}.$$

► **Theorem 1.** *Let S be a finite and non-empty set of points in the plane that is in convex position, and let $t > t^*$ be a real number. Then, there exists a plane t -spanner of S .*

Proof. Consider algorithm PLANESPANNER(S, t) and the graph $G = (S, E)$ that is returned by this algorithm. Initially, $B = S$. This graph G is obtained by iteratively cutting an ear of $CH(B)$. Therefore, G is a plane triangulation of $CH(S)$.

If $|B| \leq 3$, then E is the set of edges of the convex hull of S . Thus, G is 1-spanner. Assume $|B| > 3$. Consider one iteration of the **while** loop. Since $t > t^*$, there exists a t -good point in B ; let p be such a point that is chosen in line 4 of algorithm PLANESPANNER(S, t). Let q and r be the two neighbors of p on $CH(B)$. We add the edge (q, r) to E , and remove the point p from B . See Figure 1(a). Since E contains the convex hull of B , it follows that for any point p' in B the shortest-path distance between p and p' in G is at most $|\delta_{CH(B)}^*(p, p')|$, which is at most $t|pp'|$. Therefore, the graph G is a t -spanner of S . ◀

In order to apply this result, we need an estimate on the value of t^* :

Algorithm 1 PLANESPANNER(S, t)**Input:** A finite set S of points in the plane in convex position, and a real number $t > t^*$.**Output:** A plane t -spanner of S .

- 1: $E \leftarrow$ the set of edges of $CH(S)$
- 2: $B \leftarrow S$
- 3: **while** $|B| \geq 4$ **do**
- 4: $p \leftarrow$ a t -good point in B
- 5: $q, r \leftarrow$ the two neighbors of p on $CH(B)$
- 6: $E \leftarrow E \cup \{(q, r)\}$
- 7: $B \leftarrow B \setminus \{p\}$
- 8: **return** $G = (S, E)$

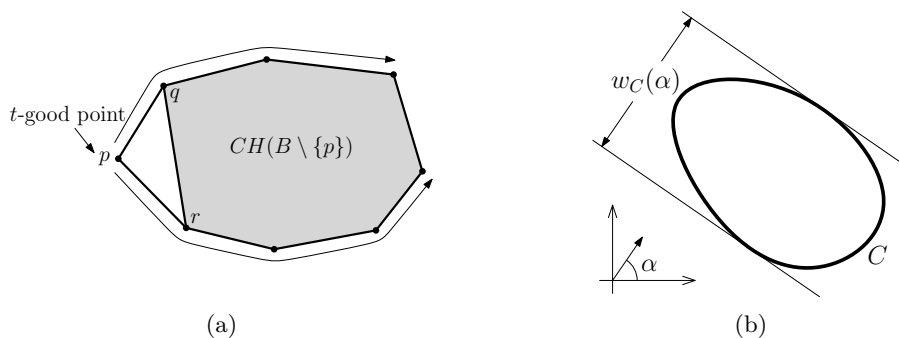

■ **Figure 1** (a) The point p is t -good. The bold edges belong to G . (b) $w_C(\alpha)$ in direction α .

► **Problem.** *Is the value of t^* finite? If it is, determine upper and lower bounds on t^* .*

Our main result is a proof that $\sqrt{3} \leq t^* \leq 1.88$. In Section 2, we provide some preliminaries. In Section 3, we prove that any point of S that is an endpoint of diameter is 1.88-good. In Section 4, we consider an approximate diametral pair of S and prove that both points in this pair are 1.88-good. Based on this, in Section 5, we show how to construct a plane 1.88-spanner for S in $O(n)$ time, assuming that the points of S are given in sorted order along $CH(S)$. Some further results are given in Section 6. Concluding remarks and open problems are given in Section 7.

2 Preliminaries

For any two points p and q in the plane let pq denote the line segment between p and q , and let $R(p \rightarrow q)$ denote the ray emanating from p and passing through q . For a point p and a real number $\rho > 0$, let $C(p, \rho)$ be the closed disk of radius ρ that is centered at p . For any two points p and q in the plane let $L(p, q)$ denote the lune of p and q , which is the intersection of $C(p, |pq|)$ and $C(q, |pq|)$.

Let S be a finite and non-empty set of points in the plane. The *diameter* of S is the largest distance among the distances between all pairs of points of S . Any pair of points whose distance is equal to the diameter is called a *diametral pair*. Any point of any diametral pair of S is called a *diametral point*.

► **Observation 2.** *Let S be a finite set of at least two points in the plane, and let $\{p, q\}$ be any diametral pair of S . Then, the points of S lie in $L(p, q)$.*

The following theorem is a restatement of Theorem 7.11 in [1].

► **Theorem 3** (See [1]). *If C_1 and C_2 are convex polygonal regions with $C_1 \subseteq C_2$, then the length of the boundary of C_1 is at most the length of the boundary of C_2 .*

We also restate the following two-dimensional version of Cauchy's surface-area formula. For a closed convex curve C in the plane let $w_C(\alpha)$ be the width of C in direction α ; see Figure 1(b).

► **Theorem 4** (Cauchy [2]). *The length $|C|$ of the boundary of a closed convex curve C in the plane is given by*

$$|C| = \int_0^\pi w_C(\alpha) d\alpha.$$

► **Lemma 5.** *Let S be a finite set of at least two points in the plane that is in convex position, and whose diameter is D . Then, for any two points p and q in S , $|\delta_{CH(S)}^*(p, q)| \leq \frac{D\pi}{2}$.*

Proof. Since $CH(S)$ is a closed convex polygonal curve and the width of $CH(S)$ in any direction is at most the diameter of S , i.e. D , we have, by Theorem 4,

$$|CH(S)| = \int_0^\pi w_{CH(S)}(\alpha) d\alpha \leq \int_0^\pi D d\alpha = D\pi.$$

Since p and q belong to $CH(S)$, there are two edge-disjoint paths between p and q along $CH(S)$. The length of the shorter one, i.e. $\delta_{CH(S)}^*(p, q)$, is at most $\frac{D\pi}{2}$. ◀

► **Lemma 6.** *Let $t \geq 1$ be a real number and let S be a finite set of at least two points in the plane that is in convex position and whose diameter is D . Let p and s be any pair of distinct points of S such that $|ps| \geq \frac{D\pi}{2t}$. Then $t \geq \frac{\pi}{2}$ and p is t -good for s .*

Proof. Since the diameter of S is D , we have $|ps| \leq D$. Thus $\frac{D\pi}{2t} \leq |ps| \leq D$, which implies $t \geq \frac{\pi}{2}$. By Lemma 5, we have $|\delta_{CH(S)}^*(p, s)| \leq \frac{D\pi}{2}$. Thus,

$$\frac{|\delta_{CH(S)}^*(p, s)|}{|ps|} \leq \frac{D\pi/2}{D\pi/2t} = t,$$

which implies that p is t -good for s . ◀

► **Lemma 7.** *Let a , b , and c be three points in the plane, let $\beta = \angle abc$, and let $t \geq 1$ be a real number. If $\beta \geq 2 \arcsin(\frac{1}{t})$, then $\frac{|ab|+|bc|}{|ac|} \leq t$.*

Proof. Refer to Figure 2(a). Consider the triangle $\triangle abc$. Let ℓ be the bisector of β , and let d be the intersection point of ℓ and ac . Let a' (resp. c') be the point on ℓ that is closest to a (resp. c). We have $|ab| = |aa'|/\sin(\beta/2)$ and $|bc| = |cc'|/\sin(\beta/2)$. Thus,

$$\frac{|ab|+|bc|}{|ac|} = \frac{|aa'|+|cc'|}{|ac| \sin\left(\frac{\beta}{2}\right)} \leq \frac{|ad|+|dc|}{|ac| \sin\left(\frac{\beta}{2}\right)} = \frac{1}{\sin\left(\frac{\beta}{2}\right)} \leq \frac{1}{\sin\left(2 \arcsin\left(\frac{1}{t}\right)/2\right)} = t. \quad \blacktriangleleft$$

► **Theorem 8.** $t^* \geq \sqrt{3}$.

Proof. Let $S = \{p, q, r, p', q', r'\}$ be the set of six points in the plane and in convex position as shown in Figure 2(b). The points p , q , and r are the vertices of an equilateral triangle of side-length 1. The point p' is placed in the middle of qr ; q' and r' are placed analogously. The

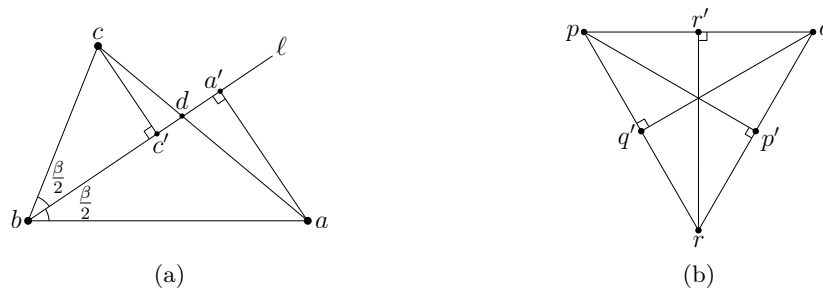

Figure 2 (a) Proof of Lemma 7. (b) Proof of Theorem 8.

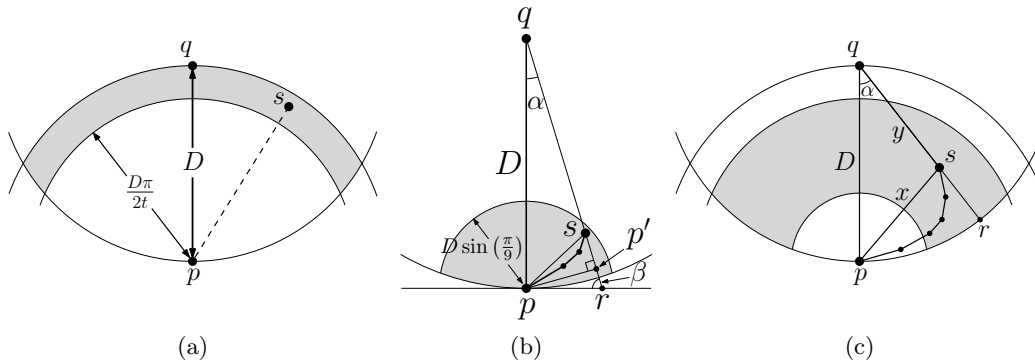

Figure 3 Illustration of the proof of Theorem 9.

two paths between p and p' along $CH(S)$ have lengths equal to $3/2$. Moreover, $|pp'| = \sqrt{3}/2$. Thus,

$$\frac{|\delta_{CH(S)}^*(p, p')|}{|pp'|} = \frac{3/2}{\sqrt{3}/2} = \sqrt{3}.$$

Therefore, for any $\varepsilon > 0$, p is not $(\sqrt{3} - \varepsilon)$ -good for p' , and vice versa. This implies that none of p, p' , and similarly, none of q, q', r, r' is $(\sqrt{3} - \varepsilon)$ -good for S . ◀

3 Diametral Points are Good

In this section we will prove the following theorem.

► **Theorem 9.** *Let S be a finite set of at least two points in the plane that is in convex position. Then any diametral point of S is 1.88-good for S .*

Throughout the rest of this section, let $t = 1.88$. Let D be the diameter of S , and let $\{p, q\}$ be any diametral pair of S , that is, $|pq| = D$. We are going to show that both p and q are t -good for S . Because of symmetry, it suffices to show that p is t -good. By Observation 2, all points of S are in the intersection of $C(p, D)$ and $C(q, D)$; see Figure 3.

Let s be any point of $S \setminus \{p\}$. We are going to show that p is t -good for s . If $s = q$, then as a consequence of Lemma 5, p is $\frac{\pi}{2}$ -good for s and, thus, p is t -good for s . Assume $s \neq q$. Depending on $|ps|$ we differentiate between the following three cases:

- $|ps| > \frac{D\pi}{2t}$. By Lemma 6, p is t -good for s ; see Figure 3(a).
- $|ps| < D \sin(\frac{\pi}{9})$. Without loss of generality assume s is to the right of $R(p \rightarrow q)$. See Figure 3(b). Let r be the intersection point of $R(q \rightarrow s)$ with the line that is perpendicular

to pq and passes through p . Consider the path $\delta_{CH(S)}^{ccw}(p, s)$. Because of convexity, this path is to the right of $R(q \rightarrow s)$ and to the right of $R(p \rightarrow s)$. By Theorem 3, we have $|\delta_{CH(S)}^{ccw}(p, s)| \leq |pr| + |rs|$. Let $\alpha = \angle pqs$ and $\beta = \angle prs = \angle prq$. Let p' be the orthogonal projection of p onto $R(q \rightarrow s)$. Then $\sin \alpha = \frac{|pp'|}{|pq|} \leq \frac{|ps|}{|pq|} = \frac{|ps|}{D} < \sin(\frac{\pi}{9})$ and, thus, $\alpha < \frac{\pi}{9}$. This implies that $\beta = \frac{\pi}{2} - \alpha > \frac{7\pi}{18}$. Since $t = 1.88$, we have $\beta > \frac{7\pi}{18} > 2 \arcsin(\frac{1}{t})$. Thus, using Lemma 7, we have

$$\frac{|\delta_{CH(S)}^*(p, s)|}{|ps|} \leq \frac{|\delta_{CH(S)}^{ccw}(p, s)|}{|ps|} \leq \frac{|pr| + |rs|}{|ps|} \leq t,$$

which implies that p is t -good for s .

- $D \sin(\frac{\pi}{9}) \leq |ps| \leq \frac{D\pi}{2t}$. Refer to Figure 3(c). Observe that if s is on pq , then p is 1-good for s . Without loss of generality assume s is to the right of $R(p \rightarrow q)$. Let r be the intersection point of $R(q \rightarrow s)$ and the boundary of $C(q, D)$. Consider the path $\delta_{CH(S)}^{ccw}(p, s)$. Because of convexity, this path is to the right of $R(q \rightarrow s)$ and to the right of $R(p \rightarrow s)$. Note that $|\delta_{CH(S)}^*(p, s)| \leq |\delta_{CH(S)}^{ccw}(p, s)|$, and by Theorem 3 we have $|\delta_{CH(S)}^{ccw}(p, s)| \leq |rs| + |\widehat{pr}|$, where $|\widehat{pr}|$ denotes the length of the counter-clockwise arc on $C(q, D)$ from p to r . In order to prove that p is t -good for s it is sufficient to prove that

$$\frac{|rs| + |\widehat{pr}|}{|ps|} \leq t,$$

which is equivalent to

$$t|ps| - |rs| - |\widehat{pr}| \geq 0. \quad (1)$$

Let $x = |ps|$, $y = |qs|$, and $\alpha = \angle pqs$. Notice that $D \sin(\frac{\pi}{9}) \leq x \leq \frac{D\pi}{2t}$, $y \leq D$, and $0 \leq \alpha \leq \frac{\pi}{2}$. By the law of cosines we have $x^2 = D^2 + y^2 - 2Dy \cos \alpha$, which implies that

$$y = D \cos \alpha \pm \sqrt{x^2 + D^2(\cos^2 \alpha - 1)}.$$

For a fixed value of α , x is minimum when $R(q \rightarrow s)$ is tangent to $C(p, x)$. This implies that $x \geq D \sin \alpha$, and consequently $\alpha \leq \arcsin(\frac{x}{D})$. Note that $|rs| = D - y$ and $|\widehat{pr}| = D\alpha$. Thus, in view of Inequality (1) we have to show that

$$tx - |rs| - |\widehat{pr}| = tx - \left(D - \left(D \cos \alpha \pm \sqrt{x^2 + D^2(\cos^2 \alpha - 1)} \right) \right) - D\alpha \geq 0, \quad (2)$$

for all $D \sin(\frac{\pi}{9}) \leq x \leq \frac{D\pi}{2t}$ and $0 \leq \alpha \leq \arcsin(\frac{x}{D})$. Without loss of generality assume that $D = 1$. Observe that in the range for x and α , the radicand in $\sqrt{x^2 + \cos^2 \alpha - 1}$ is non-negative. Also, it is sufficient to show that Inequality (2) holds for the minus sign in the \pm . That is, it is sufficient to show that

$$tx - \alpha - 1 + \cos \alpha - \sqrt{x^2 + \cos^2 \alpha - 1} \geq 0, \quad (3)$$

for all $\sin(\frac{\pi}{9}) \leq x \leq \frac{\pi}{2t}$ and $0 \leq \alpha \leq \arcsin(x)$.

In the full version of the paper we prove that Inequality (3) holds for $t \approx 1.879534$ and $t < 1.88$. This implies that p is 1.879534-good, and consequently 1.88-good for s . The sketch of the proof is given in Section 4. In fact, in Section 4 we will prove a slightly stronger result:

$$tx - \alpha - (1 + 3 * 10^{-4}) + \cos \alpha - \sqrt{x^2 + \cos^2 \alpha - 1} \geq 0$$

holds for $t = 1.879534$ and all $\sin(\frac{\pi}{9}) \leq x \leq \frac{1.0001\pi}{2t}$ and $0 \leq \alpha \leq \arcsin(x)$.

We can show that Inequality (3) holds for $t = 1.879534$ and $0 \leq x \leq \frac{\pi}{2t}$. However, we considered $x = |ps| \leq D \sin(\frac{\pi}{9})$ as a different case in order to unify the proof for Inequality (3) with the proof for Inequality (4) that we will see in Section 4.

4 Approximate-Diametral Points are Good

Let S be a finite set of at least two points in the plane that is in convex position. In Section 3 we proved that any diametral point of S is 1.88-good. In this section, we first present an algorithm that computes an approximate diametral pair of S ; this algorithm is due to Janardan [9]. Then we show that the two points obtained by this algorithm are 1.88-good for S . In Section 5, we use this algorithm to compute a plane 1.88-spanner in linear time.

Let $c \geq 2$ be an integer-valued parameter. We use a family of coordinate systems, \mathcal{C}_i , $1 \leq i \leq c$, with orthogonal axes X_i and Y_i , respectively, where X_1 is horizontal and for $i = 2, \dots, c$, X_i makes an angle of π/c with X_{i-1} . For each i we refer to the pair of points with minimum and maximum X_i -coordinates as the *extreme pair* in \mathcal{C}_i . To find an approximate diametral pair, we determine the Euclidean distance of the extreme pair in each \mathcal{C}_i and report the pair that is farthest apart. The following lower bound on the distance of the reported extreme pair has been established by Janardan [9].

► **Lemma 10** (see Janardan [9]). *Let S be a finite set of at least two points in the plane that is in convex position, and whose diameter is D . Let p and q be the pair of points obtained by running the above algorithm on S . Then $|pq| \geq \sin\left(\frac{c-1}{c}\frac{\pi}{2}\right) D$.*

In the rest of this section we will prove the following theorem.

► **Theorem 11.** *Let S be a finite set of at least two points in the plane that is in convex position. Let p and q be the pair of points obtained by running the above algorithm on S with $c = 112$. Then both p and q are 1.88-good for S .*

Throughout the rest of this section, let $t = 1.88$. Because of symmetry, we prove Theorem 11 only for p . For each $i \in \{1, \dots, 112\}$ and for each point $s \in S$, let $X_i(s)$ be the X_i -coordinate of s in the coordinate system \mathcal{C}_i . Moreover, let $l_i(s)$ be the line passing through s that is parallel to Y_i .

Let \mathcal{C}_{pq} be the set of all coordinate systems in which p and q are the extreme pair. Note that \mathcal{C}_{pq} is not empty, because p and q are the pair of points reported by the algorithm, and hence they are extreme pairs in at least one of the coordinate systems. Let $\mathcal{C}_{pq} = \{\mathcal{C}_{i_1}, \dots, \mathcal{C}_{i_m}\}$, where $1 \leq m \leq 112$. Note that for each $j \in \{i_1, \dots, i_m\}$ the points of S lie in the slab between the two parallel lines $l_j(p)$ and $l_j(q)$. For each \mathcal{C}_j , where $j \in \{i_1, \dots, i_m\}$, let r_j be the point on $l_j(q)$ such that $\angle pr_jq = \frac{\pi}{2}$, and let $\alpha_j = \angle qpr_j$; observe that $\alpha_j \leq \frac{\pi}{2}$. See Figure 4.

Let k be an element of $\{i_1, \dots, i_m\}$ for which α_k is minimum. Recall that all points of S are in the slab between $l_k(p)$ and $l_k(q)$.

► **Lemma 12.** $\alpha_k \leq \frac{\pi}{112}$.

Proof. The proof is by contradiction; thus, we assume that $\alpha_k > \frac{\pi}{112}$. Without loss of generality, assume $l_k(p)$, and consequently $l_k(q)$, are horizontal, p is below q , and q is to the right of $R(p \rightarrow r_k)$; see Figure 4. Let l_p and l_q be the lines that are perpendicular to pq and pass through p and q , respectively. Observe that each of l_p and l_q makes angle α_k with each of $l_k(p)$ and $l_k(q)$. Since $\alpha_k > \frac{\pi}{112}$, there is a coordinate system $\mathcal{C}_{k'} \in \{\mathcal{C}_1, \dots, \mathcal{C}_{112}\}$ that is different from \mathcal{C}_k and for which $l_{k'}(p)$ (resp. $l_{k'}(q)$) makes angle $\frac{\pi}{112}$ with $l_k(p)$ (resp. $l_k(q)$) and angle $\alpha_k - \frac{\pi}{112} > 0$ with l_p (resp. l_q). See Figure 4. We consider the following two cases.

- *All points of $S \setminus \{p, q\}$ are between $l_{k'}(p)$ and $l_{k'}(q)$.* Then all points of S lie in the shaded area in Figure 4(a). In this case p and q are the extreme pair in $\mathcal{C}_{k'}$. Thus $\mathcal{C}_{k'} \in \mathcal{C}_{pq}$ with $\alpha_{k'} = \alpha_k - \frac{\pi}{112}$. This contradicts our choice of k .

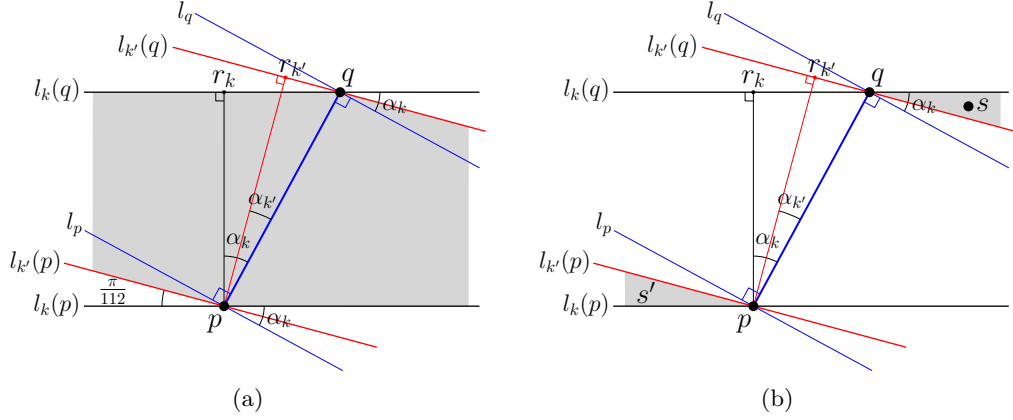

■ **Figure 4** Proof of Lemma 12.

- *There is a point of $S \setminus \{p, q\}$ below $l_{k'}(p)$ or above $l_{k'}(q)$.* Without loss of generality assume there is a point of $S \setminus \{p, q\}$ that is above $l_{k'}(q)$. See Figure 4(b). In this case one of the extreme points of $C_{k'}$, say s , is above $l_{k'}(q)$ and its other extreme point, say s' , is on or below $l_{k'}(p)$. Note that s is different from q while s' can be p . Observe that $|ss'| \geq |sp| > |pq|$. This contradicts the algorithm's choice of p and q as the farthest pair among the extreme pairs of all coordinate systems C_1, \dots, C_{112} . ◀

Let D be the diameter of S . Recall that p and q are the pair of points that are returned by Janardan's algorithm. Let $|pq| = d$. By Lemma 10, we have

$$d \geq \sin\left(\frac{111\pi}{224}\right) D > 0.999901D,$$

and thus,

$$D < 1.0001d.$$

Note that all points of S are in the intersection of the two disks $C(p, D)$ and $C(q, D)$. See Figure 5. Let s be any point of S . We are going to show that p is t -good for s . Depending on $|ps|$ we consider the following three cases:

- $|ps| > \frac{D\pi}{2t}$. By Lemma 6, p is t -good for s .
- $|ps| < d \sin\left(\frac{\pi}{9}\right)$. Consider the coordinate system C_k . Recall that C_k belongs to C_{pq} , and by Lemma 12 we have $\alpha_k = \angle qpr_k \leq \frac{\pi}{112}$. Thus, q belongs to an interval $[q_1, q_2]$ on $l_k(q)$ such that $\angle q_1pr_k = \angle q_2pr_k = \frac{\pi}{112}$ and for each point $q' \in [q_1, q_2]$ we have $\angle q'pr_k \leq \frac{\pi}{112}$. Without loss of generality assume s is to the right of $R(p \rightarrow q)$. See Figure 5(a). Let r be the intersection point of $R(q \rightarrow s)$ with $l_k(p)$. Consider the path $\delta_{CH(S)}^{ccw}(p, s)$. Because of convexity, this path is to the right of $R(q \rightarrow s)$ and to the right of $R(p \rightarrow s)$. By Theorem 3, we have $|\delta_{CH(S)}^{ccw}(p, s)| \leq |pr| + |rs|$. Let $\alpha = \angle pqs$ and $\beta = \angle prs = \angle prq$. As in the proof of Theorem 9, we have $\sin \alpha \leq \frac{|ps|}{|pq|} = \frac{|ps|}{d} < \sin\left(\frac{\pi}{9}\right)$ and, thus, $\alpha < \frac{\pi}{9}$. Since $\angle qpr \leq \frac{\pi}{2} + \frac{\pi}{112}$, it follows that $\beta = \pi - \alpha - \angle qpr > \pi - \frac{\pi}{9} - \left(\frac{\pi}{2} + \frac{\pi}{112}\right) = \frac{383\pi}{1008}$. Since $t = 1.88$, we have $\beta > 2 \arcsin\left(\frac{1}{t}\right)$. Thus, using Lemma 7, we have

$$\frac{|\delta_{CH(S)}^*(p, s)|}{|ps|} \leq \frac{|\delta_{CH(S)}^{ccw}(p, s)|}{|ps|} \leq \frac{|pr| + |rs|}{|ps|} \leq t,$$

which implies that p is t -good for s .

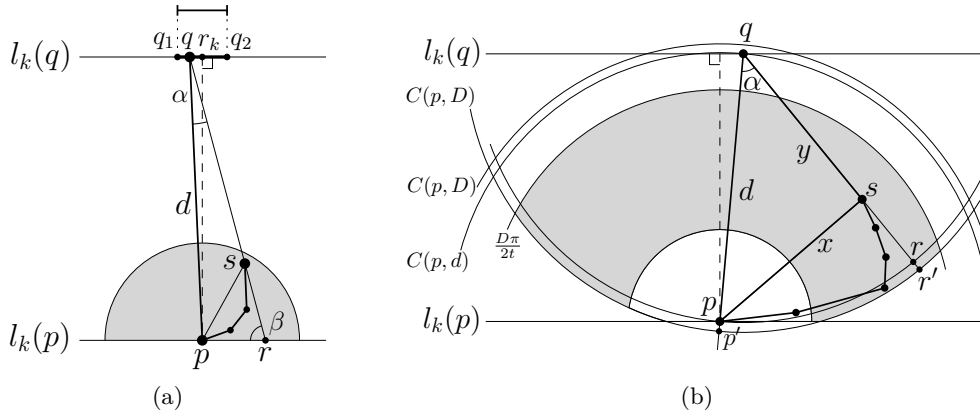

■ **Figure 5** Proof of Theorem 11: (a) $|ps| < d \sin(\frac{\pi}{9})$, and (b) $d \sin(\frac{\pi}{9}) \leq |ps| \leq \frac{D\pi}{2t}$.

- $d \sin(\frac{\pi}{9}) \leq |ps| \leq \frac{D\pi}{2t}$. In this case s is in the shaded region of Figure 5(b). Consider $C(q, d)$ and $C(q, D)$; note that all points of S are in $C(q, D)$. Without loss of generality assume s is to the right of $R(p \rightarrow q)$. Let r and r' be the intersection points of $R(q \rightarrow s)$ with the boundaries of $C(q, d)$ and $C(q, D)$, respectively. Let p' be the intersection point of $R(q \rightarrow p)$ with the boundary of $C(q, D)$. Consider the path $\delta_{CH(S)}^{ccw}(p, s)$. Because of convexity, this path is to the right of $R(q \rightarrow s)$ and to the right of $R(p \rightarrow s)$. See Figure 5(b). Thus, Theorem 3 implies that $|\delta_{CH(S)}^{ccw}(p, s)| \leq |pp'| + |\widehat{p'r'}| + |r'r| + |rs|$, where $|\widehat{p'r'}|$ denotes the length of the counter-clockwise arc on $C(q, D)$ from p' to r' . Note that $|pp'| = |r'r| = D - d < 0.0001d$. Let $\alpha = \angle pqs$. Note that α is maximum when $R(q \rightarrow s)$ is tangent to $C(p, \frac{D\pi}{2t})$. This implies that $\alpha \leq \arcsin(\frac{D\pi}{2td}) < \arcsin(\frac{1.0001\pi}{2t}) < 1$. Thus,

$$|\widehat{p'r'}| = D\alpha < 1.0001d\alpha = d\alpha + 0.0001d\alpha < |\widehat{pr}| + 0.0001d,$$

where $|\widehat{pr}|$ denotes the length of the counter-clockwise arc on $C(q, d)$ from p to r . Therefore, we have

$$|\delta_{CH(S)}^*(p, s)| \leq |\delta_{CH(S)}^{ccw}(p, s)| \leq |pp'| + |\widehat{p'r'}| + |r'r| + |rs| < |rs| + |\widehat{pr}| + 0.0003d.$$

In order to prove that p is t -good for s , it is sufficient to prove that

$$\frac{|rs| + |\widehat{pr}| + 0.0003d}{|ps|} \leq t,$$

or equivalently

$$t|ps| - |rs| - |\widehat{pr}| - 0.0003d \geq 0,$$

for all $d \sin(\frac{\pi}{9}) \leq |ps| \leq \frac{D\pi}{2t}$. Without loss of generality assume that $d = 1$, and thus, $D < 1.0001$. In view of the proof of Theorem 9 it turns out that we have to prove that

$$tx - \alpha - (1 + 3 * 10^{-4}) + \cos \alpha - \sqrt{x^2 + \cos^2 \alpha - 1} \geq 0, \quad (4)$$

for all $\sin(\frac{\pi}{9}) \leq x \leq \frac{1.0001\pi}{2t}$ and $0 \leq \alpha \leq \arcsin(x)$.

In the full version of the paper we prove that Inequality (4) holds for $t \approx 1.879534$ and $t < 1.88$. This implies that p is 1.879534-good, and consequently 1.88-good for s .

25:10 A Plane 1.88-Spanner for Points in Convex Position

To prove Inequality (4) we do the following. Let $\varepsilon = 10^{-4}$. The goal is to find the smallest value of t such that

$$tx - \alpha - (1 + 3\varepsilon) + \cos(\alpha) - \sqrt{x^2 + \cos^2(\alpha) - 1} \geq 0,$$

for all $\sin(\frac{\pi}{9}) \leq x \leq \frac{(1+\varepsilon)\pi}{2t}$, $0 \leq \alpha \leq \arcsin(x)$. Note that for the left-hand side of the inequality to be well-defined, we need $x^2 + \cos^2(\alpha) \geq 1$. Since $x \leq \frac{(1+\varepsilon)\pi}{2t}$, we can re-write the constraints on α as $0 \leq \alpha \leq \arcsin(\frac{(1+\varepsilon)\pi}{2t}) = \arccos(\sqrt{1 - (\frac{(1+\varepsilon)\pi}{2t})^2})$.

Let $u = \cos(\alpha)$. This problem is equivalent to finding the smallest value of t for which

$$f(x, u) = tx - \arccos(u) - (1 + 3\varepsilon) + u - \sqrt{x^2 + u^2 - 1} \geq 0, \quad (5)$$

for all $\sin(\frac{\pi}{9}) \leq x \leq \frac{(1+\varepsilon)\pi}{2t}$, $\sqrt{1 - (\frac{(1+\varepsilon)\pi}{2t})^2} \leq u \leq 1$ and $x^2 + u^2 \geq 1$.

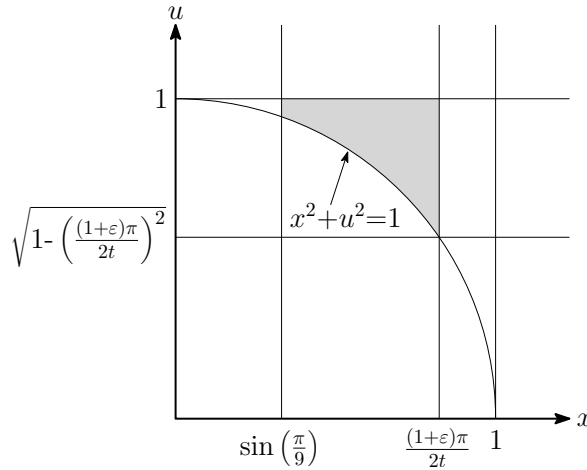

Thus we want to verify the validity of Inequality (5) in the shaded region of the above figure. In the full version of the paper we show that for $t \approx 1.879534$, $f(x, u) \geq 0$ in the region defined by the constraints on x and u .

5 Algorithms

Let S be a set of n points in the plane that is in convex position. We assume that the points of S are given in sorted order along $CH(S)$. In this section, we describe how to construct a plane 1.88-spanner on S in $O(n)$ time.

By Theorem 9, any diametral point of S is 1.88-good for S . As discussed in the proof of Theorem 1, by running algorithm `PLANESPANNER($S, 1.88$)`, a plane 1.88-spanner for S is obtained. Specifically, we obtain this spanner by choosing, in line 4 of the algorithm, a diametral point of S . Since the diameter of n points in convex position can be computed in $O(n)$ time, the algorithm runs in $O(n^2)$ time.

Note that in each iteration of the **while** loop in algorithm `PLANESPANNER`, we remove one point from S . Thus, any deletion-only data structure that maintains the diameter of S can be used here. In 2010, Chan [3] showed that the diameter of a fully dynamic point set in the plane can be maintained in $O(\log^8 n)$ expected amortized time. Based on that, algorithm `PLANESPANNER` can be implemented to run in $O(n \log^8 n)$ expected time.

Recall that in Section 4, we presented an algorithm that computes an approximate diametral pair of S . By Theorem 11, these diametral points are 1.88-good (assuming $c = 112$). Based on this algorithm, we present a deletion-only data structure that maintains an approximate diametral pair of S . For each i , $1 \leq i \leq c$, we store the points of \mathcal{C}_i in a doubly connected linked list, L_i , in increasing order of their X_i -coordinates. The list L_i can be constructed in $O(n)$ time by merging the two convex chains of the points between the extreme pair in \mathcal{C}_i . The list L_i allows access to the extreme pair in \mathcal{C}_i in $O(1)$ time, via explicitly-maintained pointers to the leftmost and rightmost nodes. For $i = 1, \dots, c - 1$ and for each point p in L_i , we store a cross pointer to the occurrence of p in L_{i+1} . Moreover, for any point p in L_c we store a cross pointer to the occurrence of p in L_1 . To delete a point p from S , we delete p from each L_i , $1 \leq i \leq c$. If we are given a pointer to p 's occurrence in one list L_i , then p can be deleted in $O(c)$ time by following the cross pointers. To answer a diameter query, we determine the Euclidean distance of the extreme pair in each L_i and report the pair that is farthest apart; this takes $O(c)$ time. We use this data structure, with $c = 112$, in line 4 of algorithm PLANESPANNER. Thus, each query takes $O(1)$ time and gives two pointers to the approximated diametral points. Using the cross pointers, the approximated diametral points can be deleted in $O(1)$ time. Thus, algorithm PLANESPANNER can be implemented to run in $O(n)$ time. Therefore, we have proved the following theorem.

► **Theorem 13.** *Let S be a set of n points in the plane that is in convex position. Assume that the points of S are given in sorted order along the boundary of the convex hull of S . Then a plane 1.88-spanner for S can be computed in $O(n)$ time.*

6 Remarks

1. *There exists a point set in the plane and in convex position such that some of its diametral points are not 1.868-good.*

The figure below shows a point set S that contains the points p, q, r, s, p' and many points that are uniformly distributed on each of the arcs \widehat{qr} and \widehat{rs} .

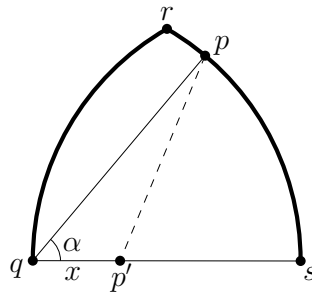

The points q, r , and s are the vertices of an equilateral triangle of side length 1. The arc \widehat{qr} (resp. \widehat{rs}) has radius 1 and is centered at s (resp. q). The point p' is placed on qs and at distance x from q . The point p is placed on \widehat{rs} such that $\angle p'qp = \alpha$. Note that $0 < x < 1$ and $0 < \alpha < \pi/3$. We will compute the exact values of x and α later. Note that all points of S , except p' , are diametral points. Moreover $|CH(S)| \approx 1 + \frac{2\pi}{3}$. We are going to place p and p' (or equivalently, choosing α and x) such that p is not 1.868-good for p' , and hence it is not 1.868-good for S .

We place p and p' such that the lengths of the two paths between p and p' on $CH(S)$ are equal to $|\delta_{CH(S)}^*(p, p')| \approx 1/2 + \pi/3$ and $|pp'|$ is minimized. In this way, $|\delta_{CH(S)}^*(p, p')|/|pp'|$

25:12 A Plane 1.88-Spanner for Points in Convex Position

is maximized. The length of the path $\delta_{CH(S)}^*(p, p')$ that is to the left of $R(p \rightarrow p')$ is $\alpha + 1 - x$. Thus, $\alpha + 1 - x = 1/2 + \pi/3$, which implies that $x = \alpha + 1/2 - \pi/3$. By the law of cosines we have

$$|pp'| = \sqrt{1 + x^2 - 2x \cos \alpha}.$$

The value of α that minimizes $|pp'|$ is the solution of the equation

$$(6\alpha + 3 - 2\pi)(1 + \sin \alpha) - 6 \cos \alpha = 0,$$

which is $\alpha \approx 0.897287$. Thus, we choose $\alpha = 0.897287$ and $x = \alpha + 1/2 - \pi/3$. For these values of α and x we have $|pp'| \approx 0.828153$ and hence,

$$\frac{|\delta_{CH(S)}^*(p, p')|}{|pp'|} \approx 1.868.$$

Thus, the diametral point p is not 1.868-good for p' , and hence is not 1.868-good for S .

2. *There exists a point set in the plane and in convex position such that none of its diametral points is 1.75-good.*

The figure below shows a point set S that contains the points p, q, r, p', q' , and many points that are uniformly distributed on the arc \widehat{pq} .

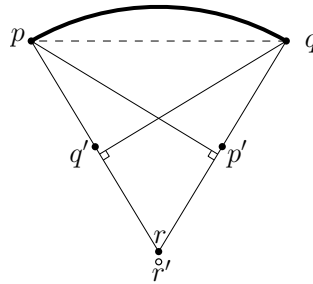

The points p, q , and r' are the vertices of an equilateral triangle of side-length 1; note that r' does not belong to S . The arc \widehat{pq} is centered at r' and has radius 1. The point r is placed at distance $\varepsilon > 0$ vertically above r' . Thus, p and q are the only diametral points in S . Moreover, $|CH(S)| \approx 2 + \frac{\pi}{3}$. The point p' (resp. q') is placed on rq (resp. rp) and at distance $\frac{\pi}{6}$ from r . Thus $|\delta_{CH(S)}^*(p, p')| = |\delta_{CH(S)}^*(q, q')| \approx 1 + \frac{\pi}{6}$. By the law of cosines we have $|pp'| = |qq'| \approx \frac{1}{6} \sqrt{36 + \pi^2 - 6\pi}$. Thus,

$$\frac{|\delta_{CH(S)}^*(p, p')|}{|pp'|} = \frac{|\delta_{CH(S)}^*(q, q')|}{|qq'|} \approx 1.758.$$

This implies that p is not 1.75-good for p' , and q is not 1.75-good for q' . Therefore, none of the diametral points of S is 1.75-good for S .

3. Intuitively, it seems that the point on the convex hull that has the smallest internal angle with its neighboring points is a suitable candidate to be a good point. But this is not true; the figure below shows a point set S that contains the points p, q, r, p', q', r' , and many points that are uniformly distributed on each of the arcs $\widehat{qq'}$ and $\widehat{rr'}$.

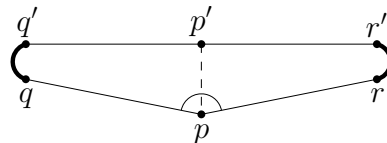

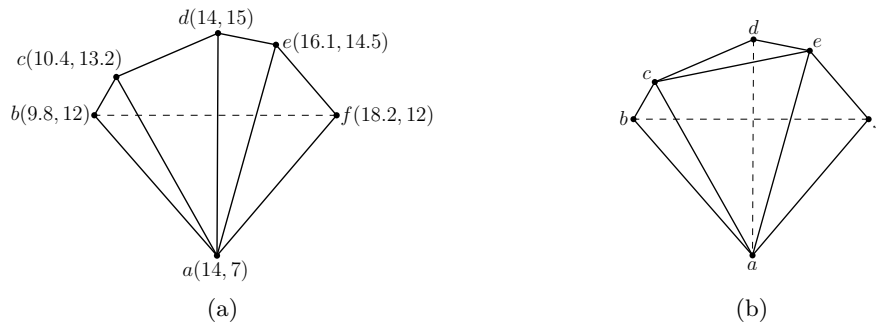

■ **Figure 6** (a) Delaunay triangulation. (b) The graph computed by algorithm PLANESPANNER when it removes both points of a diametral pair in each iteration.

The point p is placed vertically below the midpoint of qr , and p' is placed on the midpoint of $q'r'$. Depending on the lengths of pr and pq , and on the distance between p and the midpoint of qr , the value of $|\delta_{CH(S)}^*(p, p')|/|pp'|$ can be arbitrary large. Thus, for any $t > 1$, we can select S such that p is not t -good for p' , and hence it is not t -good for S .

4. There are point sets in the plane and in convex position for which the plane graph that is computed by algorithm PLANESPANNER has smaller stretch factor than the Delaunay triangulation of the same point set. Consider the set $S = \{a, b, c, d, e, f\}$ of six points in Figure 6. Figure 6(a) shows the Delaunay triangulation of S whose stretch factor is $(|bc| + |cd| + |de| + |ef|)/|bf| \approx 1.284$. Figure 6(b) shows the plane graph G obtained by algorithm PLANESPANNER when it removes both points of a diametral pair in each iteration. The points b and f are the only diametral pair in S , thus, in the first iteration ae and ac are added to G . In the next iteration a and d are the only diametral pairs, thus, the edge ec is added to G . The stretch factor of G is $(|ae| + |ed|)/|ad| \approx (|bc| + |ce| + |ef|)/|bf| \approx 1.244$. Note that there are point sets for which the Delaunay triangulation has a smaller stretch factor than the graph that is computed by algorithm PLANESPANNER.
5. The implementation of algorithm PLANESPANNER in Theorem 1 gives a simple (and surprising) $O(n)$ -time algorithm for computing the closest pair in a set of n points in convex position: As discussed in Section 5, this algorithm computes a 1.88-spanner G in $O(n)$ time. It is well known that in any t -spanner, for any $t < 2$, the closest pair is connected by an edge. Thus, given G , the closest pair can be computed in $O(n)$ time.

7 Conclusions and Future Work

For a point set S in the plane and in convex position, we have shown that any approximate diametral point of S is 1.88-good. Based on this, we obtained a plane 1.88-spanner for S in $O(n)$ time. We have proved that $\sqrt{3} \leq t^* \leq 1.88$. By solving Inequality (3) directly, or by considering more coordinate systems in the approximate-diameter algorithm, we can show that any (approximate) diametral point of S is 1.8792-good. This implies that $t^* \leq 1.8792$. A natural problem is to improve any of the provided bounds. Another natural problem is to extend algorithm PLANESPANNER to point sets that are not in convex position.

References

- 1 R. V. Benson. *Euclidean geometry and convexity*. McGraw-Hill, 1966.
- 2 A. L. Cauchy. Note sur divers théorèmes relatifs à la rectification des courbes et à la quadrature des surfaces. *C. R. Acad. Sci. Paris*, 13:1060–1065, 1841.
- 3 T. M. Chan. A dynamic data structure for 3-D convex hulls and 2-D nearest neighbor queries. *J. ACM*, 57(3), 2010.
- 4 L. P. Chew. There is a planar graph almost as good as the complete graph. In *Proceedings of the 2nd ACM Symposium on Computational Geometry*, pages 169–177, 1986.
- 5 L. P. Chew. There are planar graphs almost as good as the complete graph. *Journal of Computer and System Sciences*, 39:205–219, 1989.
- 6 S. Cui, I. A. Kanj, and G. Xia. On the stretch factor of Delaunay triangulations of points in convex position. *Computational Geometry: Theory and Applications*, 44:104–109, 2011.
- 7 D. P. Dobkin, S. J. Friedman, and K. J. Supowit. Delaunay graphs are almost as good as complete graphs. *Discrete & Computational Geometry*, 5:399–407, 1990.
- 8 A. Dumitrescu and A. Ghosh. Lower bounds on the dilation of plane spanners. In *Proceedings of the 2nd International Conference on Algorithms and Discrete Applied Mathematics, CALDAM*, pages 139–151, 2016.
- 9 R. Janardan. On maintaining the width and diameter of a planar point-set online. *Int. J. Comput. Geometry Appl.*, 3(3):331–344, 1993.
- 10 J. M. Keil and C. A. Gutwin. Classes of graphs which approximate the complete Euclidean graph. *Discrete & Computational Geometry*, 7:13–28, 1992.
- 11 W. Mulzer. Minimum dilation triangulations for the regular n -gon. Master’s thesis, Freie Universität Berlin, Germany, 2004.
- 12 G. Narasimhan and M. Smid. *Geometric Spanner Networks*. Cambridge University Press, Cambridge, UK, 2007.
- 13 G. Xia. The stretch factor of the Delaunay triangulation is less than 1.998. *SIAM Journal on Computing*, 42:1620–1659, 2013.